



Project:

Item Number:

Quantity:

IMMERSION CIRCULATOR



40868

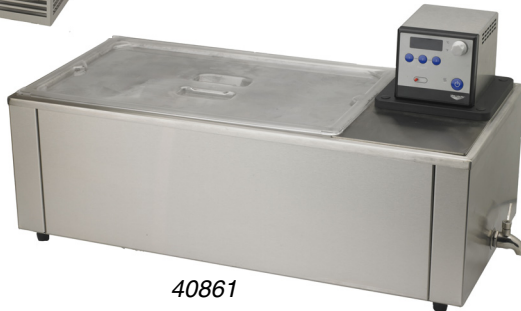

40861

Immersion Circulator

MODELS

40868 Immersion Circulator (head only)

40861 Immersion Circulator (head, bath and cover)

FEATURES

- Stainless steel housing for durability
- Temperature stability to 0.1°F (0.06°C) for precise, consistent results
- Two pump speeds for flexible cooking
- Three convenient programmable settings for ease of use
- Accurate LED Celsius or Fahrenheit temperature readouts for precise cooking
- 40861 includes a convenient factory fitted drain valve for easy cleaning
- 6 ft. (1.8m) cord and plug

DESCRIPTION

Sous Vide is a cooking method in which food is vacuum sealed in a plastic pouch and then cooked at a preset temperature in a water bath. This cooking method provides more control, and allows for perfect repeatable results.

WARRANTY: All models shown come with Vollrath's standard warranty against defects in materials and workmanship. For full warranty details, please refer to the Vollrath Equipment and Smallwares Catalog.

Agency Listings



Due to continued product improvement, please consult www.vollrathco.com for current product specifications.

Approvals	Date



Setting the Standard™

www.vollrathco.com

The Vollrath Company, L.L.C.
1236 North 18th Street
Sheboygan, WI 53081-3201 U.S.A.
Customer Service: 800.628.0830
Canada Customer Service: 800.695.8560
Main Fax: 800.752.5620 or 920.459.6573

Technical Services: 800.628.0832
Technical Services Fax: 920.459.5462

IMMERSION CIRCULATOR

MODELS 40868 Immersion Circulator (head only)
 40861 Immersion Circulator (head, bath and cover)

DIMENSIONS

Dimensions shown in inches (cm).

40868

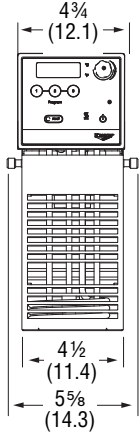

Front View

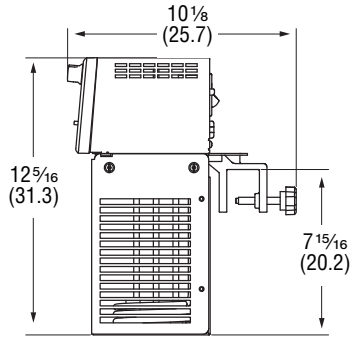

Side View

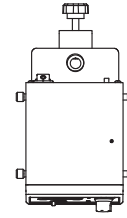

Top View

40861

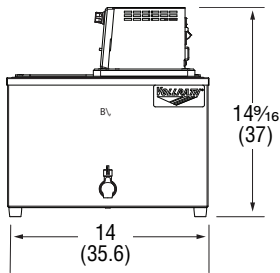

Front View

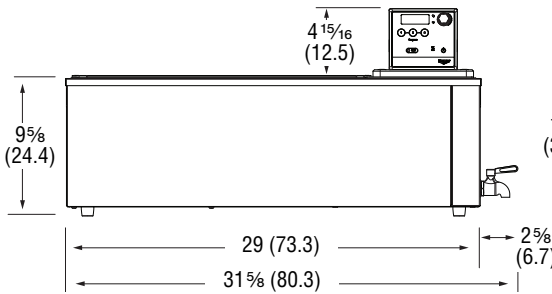

Side View

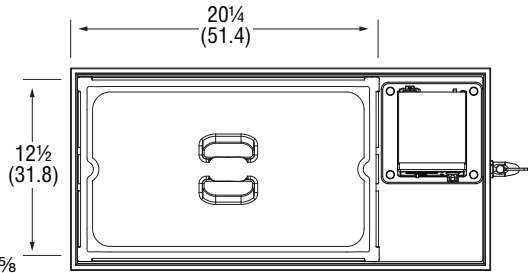

Top View

SPECIFICATIONS

Model	Voltage	Watts	Amps	Plug	Shipping Container W x D x H	Shipping Weight LB (Kg)
40868	120V	1100	11	5-15P	12 x 8 x 15 1/2 (30.5 x 20.3 x 39.4)	10 1/2 (4.8)
40861	120V	1100	11	5-15P	18 5/8 x 33 5/8 x 13 3/4 (39.7 x 85.4 x 34.9)	49 (22.2)

Receptacle

