



Outperform every day.™

Project:

Item Number:

Quantity:

## MODUSERV® MODULAR DISPENSER SYSTEM



MRBM-1

MRBM-2



MRBM-3

ModuServ® Modular Dispenser System

### DESCRIPTION

The compact ModuServ® Dispenser System receptor boxes are designed for in-counter installation. Three sizes accept a variety of components to create custom dispensing stations. Slots hold components firmly in place.

### MODELS

**MRBM-1** Small Receptor Box with Faceplate







**MRBM-2** Medium Receptor Box with Faceplate

**MRBM-3** Large Receptor Box with Faceplate

### FEATURES

- Impact-resistant molded thermoplastic construction
- Finish is mar and fingerprint resistant
- Receptor boxes include mounting screws
- Components insert without tools for easy re-arrangement
- Clear faceplate secures components in place and removes for cleaning

### COMPONENTS

-  **MCM-1** Condiment/Creamer Divider
-  **MLM-1** Lid Divider
-  **MN-1** Napkin Dispenser - Accommodates 6½" x 3½" (16.3 x 8.9 cm) Folded Napkin
-  **MN-2** Napkin Dispenser - Accommodates 6½" x 5" (16.5 x 12.7 cm) Folded Napkin
-  **MS-1A** Bulk Straw Dispenser - Accommodates straws up to 8" (20.3 cm) long x ¼ (.64 cm) diameter
-  **MS-2A** Stir Stick Dispenser - Accommodates stir sticks up to 6" (15.2 cm) long x ⅛ (.3 cm) diameter
-  **MW-1** Waxed Tissue Dispenser - Accommodates most mini-size cartons

**WARRANTY:** All models shown come with Vollrath's standard warranty against defects in materials and workmanship. For full warranty details, please refer to [www.Vollrath.com](http://www.Vollrath.com).

Approvals

Date

Due to continued product improvement, please consult [www.vollrath.com](http://www.vollrath.com) for current product specifications.



Outperform every day.™  
[www.vollrath.com](http://www.vollrath.com)

The Vollrath Company, L.L.C.  
1236 North 18th Street  
Sheboygan, WI 53081-3201 U.S.A.  
Customer Service: 800.628.0830  
Canada Customer Service: 800.695.8560  
Main Fax: 800.752.5620 or 920.459.6573

Technical Services: 800.628.0832  
Technical Services Fax: 920.459.5462

# MODUSERV® MODULAR DISPENSER SYSTEM

## DIMENSIONS (Shown in inches (cm))

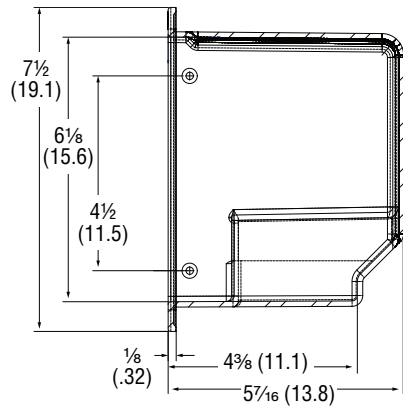

Side View - All Models

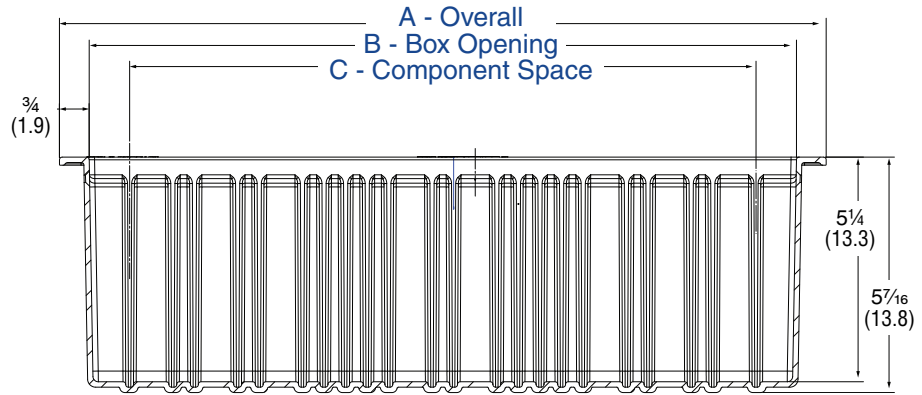

Top View - All Models  
MRBM-2 Shown

## SPECIFICATIONS

Item	Dimensions IN (CM)			
	(A)	(B)	(C)	Cutout Size
MRBM-1 - Small box	10 <sup>3</sup> / <sub>4</sub> (27.3)	9 <sup>3</sup> / <sub>8</sub> (23.8)	7 (17.8)	6 <sup>1</sup> / <sub>2</sub> x 9 <sup>3</sup> / <sub>4</sub> (16.5 x 24.8)
MRBM-2- Medium box	17 <sup>3</sup> / <sub>4</sub> (45.1)	16 <sup>3</sup> / <sub>8</sub> (41.6)	14 <sup>1</sup> / <sub>2</sub> (36.8)	6 <sup>1</sup> / <sub>2</sub> x 16 <sup>3</sup> / <sub>4</sub> (16.5 x 42.6)
MRBM-3 Large box	22 <sup>1</sup> / <sub>4</sub> (56.5)	20 <sup>7</sup> / <sub>8</sub> (53)	19 (48.3)	6 <sup>1</sup> / <sub>2</sub> x 21 <sup>1</sup> / <sub>4</sub> (16.5 x 54)
Component	Width	Height	Depth	Cutout
MCM-1 - Condiment/ creamer divider	1/8 (.32)	6 (15.3)	6 <sup>3</sup> / <sub>8</sub> (16.2)	-
MLM-1 - Lid divider	1/8 (.32)	6 (15.3)	6 <sup>3</sup> / <sub>8</sub> (16.2)	-
MN-1 - Napkin dispenser	7 <sup>1</sup> / <sub>8</sub> (18.1)	6 (15.3)	6 <sup>1</sup> / <sub>4</sub> (15.9)	-
MN-2 - Napkin dispenser	7 <sup>1</sup> / <sub>8</sub> (18.1)	6 (15.3)	6 <sup>1</sup> / <sub>4</sub> (15.9)	-
MS-1A - Straw dispenser	8 <sup>5</sup> / <sub>8</sub> (21.9)	6 (15.3)	6 <sup>1</sup> / <sub>4</sub> (15.9)	-
MS-2A - Stir stick dispenser	7 <sup>1</sup> / <sub>8</sub> (18.1)	6 (15.3)	6 <sup>1</sup> / <sub>4</sub> (15.9)	-
MW-1 - Waxed tissue dispenser	7 <sup>1</sup> / <sub>8</sub> (18.1)	6 (15.3)	6 <sup>1</sup> / <sub>4</sub> (15.9)	-

## Front Views

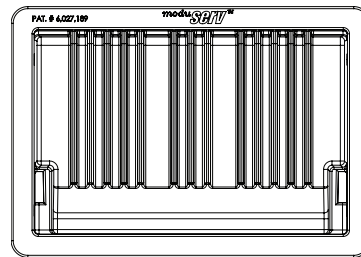

MRBM-1

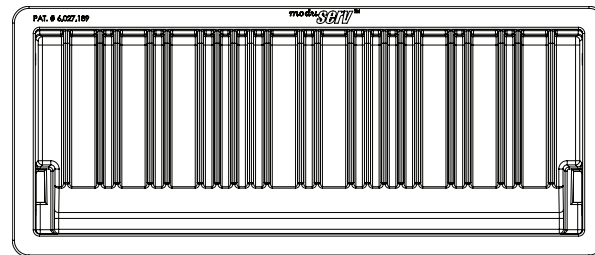

MRBM-2

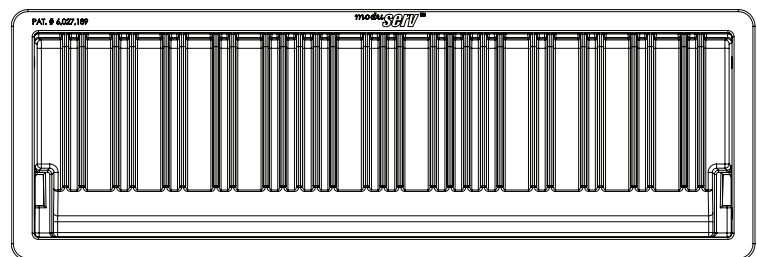

MRBM-3



Outperform every day.™

[www.vollrath.com](http://www.vollrath.com)

The Vollrath Company, L.L.C.  
1236 North 18th Street  
Sheboygan, WI 53081-3201 U.S.A.  
Customer Service: 800.628.0830  
Canada Customer Service: 800.695.8560  
Main Fax: 800.752.5620 or 920.459.6573

Technical Services: 800.628.0832  
Technical Services Fax: 920.459.5462