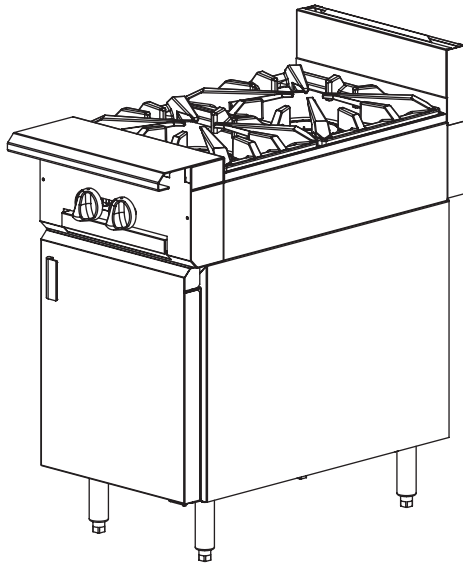

HEAVY DUTY COOKING**VULCAN****HEAVY DUTY GAS RANGE
2-BURNERS / 18" WIDE GAS RANGE**

Model V2B18B
(shown on cabinet base)

**SPECIFICATIONS**

18" wide heavy duty gas range, Vulcan Model No. V2B18 (modular) and V2B18B (cabinet base) or V2BU18 (modular) and V2BU18B (cabinet base). Stainless steel front, sides, plate ledge, front top ledge with pull-out condiment rails, stub back, and 6" adjustable legs. 1¼" diameter front gas manifold and 1¼" rear gas connection, capped. Heavy cast aeration bowls with removable cast top grates. Front grate: 11⁵/₁₆" x 17³/₈", rear grate: 14" x 17³/₈". Two 33,000 BTU/hr. heavy cast, two-piece open burners with individual pilots and controls for each burner. Total input 66,000 BTU/hr.

Exterior Dimensions:

36³/₄"d x 18"w x 36"h on 6" adjustable legs

- V2B18** 2-Burners / Modular
- V2B18B** 2-Burners / Cabinet Base
- V2BU18** 2-Burners Set-Up / Modular
- V2BU18B** 2-Burners Set-Up / Cabinet Base

STANDARD FEATURES

- Stainless steel front, front top ledge, burner box, sides, base, and stub back
- 1¼" diameter front gas manifold with 1¼" rear gas connection (capped)
- 33,000 BTU/hr. open top burners with lift off heads
- Individual pilots and controls for each burner
- Heavy-duty cast grates
- 4" stainless steel stub riser
- 6" adjustable stainless steel legs for cabinet base models (no legs for modular model)
- Stainless steel cabinet base door
- Universal rack guides, with one removable shelf (cabinet base)
- One year limited parts and labor warranty

OPTIONAL FEATURES (Factory Installed)

- Cap and cover front manifold
- 4" adjustable flanged feet for modular models
- Less legs for dolly mounting of cabinet base models
- 3" high toe base for curb mounting

ACCESSORIES (Packaged & Sold Separately)

- ¾", 1", or 1¼" gas pressure regulator (specify gas type – pack loose)
- Set of 4 casters, 6" high (two locking)
- 6" adjustable flanged feet for cabinet base models
- Extra removable shelves for use with Universal rack guides (cabinet base)
- Banking strip
- 10", 22", or 34" high back risers (no shelf)
- 22" single deck solid or flo-thru high shelf risers
- 34" double deck solid or flo-thru high shelf risers
- Flexible gas hose with quick disconnect and restraining device
- Common condiment type, telescoping plate rail (starting at 24" length)
- Dolly frames

VULCAN

a division of ITW Food Equipment Group LLC

P.O. Box 696 ■ Louisville, KY 40201 ■ Toll-free: 1-800-814-2028 ■ Local: 502-778-2791 ■ Quote & Order Fax: 1-800-444-0602



HEAVY DUTY GAS RANGE
2-BURNERS / 18" WIDE GAS RANGE

INSTALLATION INSTRUCTIONS

1. A properly sized gas pressure regulator suitable for battery or single unit application must be furnished and installed. Natural gas 6.0" W.C., propane gas 10.0" W.C.
 2. An adequate ventilation system is required for commercial cooking equipment. Information may be obtained by writing to the National Fire Protection Association, 1 Batterymarch Park, Quincy, MA 02269, www.NFPA.org. When writing, refer to NFPA No. 96.
 3. These units are manufactured for installation in accordance with ANSZ223.1A (latest edition), National Fuel Gas Code. Copies may be obtained from The American Gas Association, 400 N Capitol St. NW, Washington, DC 20001, www.AGA.org.
 4. **Clearances**

	Rear	Sides
Combustible	10"	10"
Non-combustible	0"	0"
 5. For proper combustion, install equipment on adjustable legs or casters. On curb or platform, allow 3½" front overhang. Toe base with leveling bolts are required for curb installation. Specify when ordering.
 6. Cannot be battered with GH series equipment.
 7. This appliance is manufactured for commercial installation only and is not intended for home use.
- NOTE:** In line with its policy to continually improve its product, Vulcan reserves the right to change materials and specifications without notice.

Specify type of gas when ordering.
Specify altitude when above 2,000 feet.

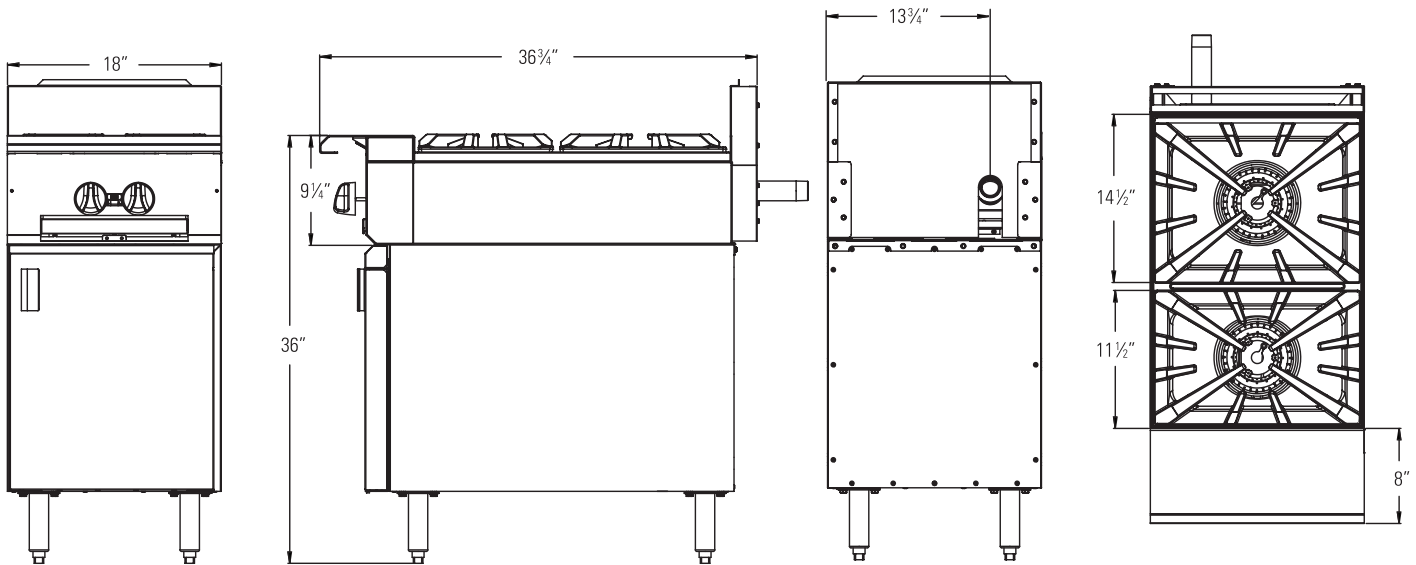

TOP CONFIGURATION	MODEL NUMBER	DESCRIPTION	TOTAL INPUT BTU / HR	SHIPPING WEIGHT LBS / KG
	V2B18	2-Burners / Modular	66,000	165 / 75
	V2B18B	2-Burners / Cabinet Base	66,000	225 / 102
	V2BU18	2-Burners / Step-Up / Modular	66,000	165 / 75
	V2BU18B	2-Burners / Step-Up / Cabinet Base	66,000	225 / 102

This appliance is manufactured for commercial use only and is not intended for home use.



a division of ITW Food Equipment Group LLC

P.O. Box 696 ■ Louisville, KY 40201 ■ Toll-free: 1-800-814-2028 ■ Local: 502-778-2791 ■ Quote & Order Fax: 1-800-444-0602

NOTE: In line with its policy to continually improve its products, Vulcan reserves the right to change materials and specifications without notice.