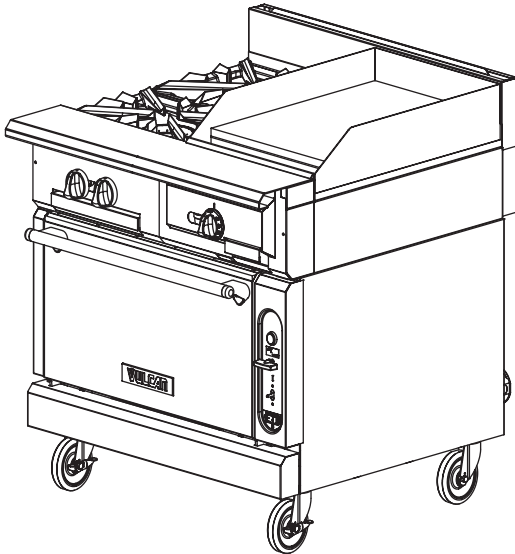

**HEAVY DUTY COOKING****VULCAN****HEAVY DUTY GAS RANGE  
2 BURNERS / 18" T-STAT GRIDDLE  
36" WIDE GAS RANGE****Model V2BG8TC**

(shown on a convection oven base)

**SPECIFICATIONS**

36" wide heavy duty gas range, Vulcan Model No. V2BG8T (modular) and V2BG8TB (cabinet base), V2BG8TS (standard oven base) or V2BG8TC (convection oven base). Modular construction for ease of installation. Stainless steel front, front top ledge, plate ledge, sides, base, stub back, and 6" adjustable legs on all "B", "S", & "C" models. Stainless steel extra deep crumb tray. Two 33,000 BTU/hr. griddle burners. Individual pilots and controls for each burner. Heavy duty cast burner grates, easy lift off 11" x 17" in front, 14" x 17" plates in rear. Grates and plates are separate from aeration bowl for ease of cleaning. 18" ground steel griddle plate. **Standard Oven:** 50,000 BTU/hr. with porcelain oven bottom, sides, and interior door panel. **Convection Oven:** 32,000 BTU/hr. with porcelain oven bottom, sides, and interior door panel (115v-1 phase blower motor, 4 amps, 9' cord & plug). Ovens measure 27"w x 27"d x 13"h. Standard oven thermostats adjust from 150° – 550°F. Convection oven adjusts from 175° – 550°F and the optional finishing oven for standard ovens adjusts from 300° – 650°F. Standard oven supplied with one rack, convection oven with two. Both ovens allow for three rack positions. Oven door is heavy-duty with counter weight door hinges. 1¼" front manifold connection. Total input 96,000 BTU/hr.

**Exterior Dimensions:**

36¾"d x 36"w x 36"h on 6" adjustable legs

- V2BG8T** 2-Burners / 18" T-Stat Griddle / Modular
- V2BG8TB** 2-Burners / 18" T-Stat Griddle / Cabinet Base
- V2BG8TS** 2-Burners / 18" T-Stat Griddle / Standard Oven
- V2BG8TC** 2-Burners / 18" T-Stat Griddle / Convection Oven

**STANDARD FEATURES**

- Stainless steel front, front top ledge, sides, base and stub back
- 1¼" diameter front gas manifold and 1¼" rear gas connection (capped)
- 33,000 BTU/hr. open top burners with lift off heads
- 30,000 BTU/hr. griddle burners
- Snap-action thermostats
- Temperatures range from 150° - 450°F
- 50,000 BTU/hr. standard oven burner
- 32,000 BTU/hr. convection oven burner
- Porcelain oven cavity
- Individual pilots and controls for each burner
- Heavy-duty cast grates
- ¾" ground steel griddle plate
- 4" stainless steel stub riser
- 6" adjustable stainless steel legs for "S", "C", and "B" models
- Stainless steel cabinet base doors for "B" models
- Universal rack guides, one removable shelf (cabinet base)
- One year limited parts and labor warranty

**OPTIONAL FEATURES (Factory Installed)**

- Cap and cover front manifold
- Stainless steel oven cavity, burner box & exterior range bottom
- 650°F oven thermostat and steel hearth. ("S" models)
- Fan cooling package. ("C" models)
- 4" adjustable flanged feet for modular models
- Less legs for dolly mounting for "S", "C", and "B" models
- 3" high toe base for curb mounting of cabinet base models

**ACCESSORIES (Packaged & Sold Separately)**

- ¾", 1", or 1¼" gas pressure regulator (specify gas type – pack loose)
- Set of 4 casters, 6" high (two locking)
- 6" adjustable flanged feet for "S", "C", and "B" models
- Extra removable shelves for use with Universal rack guides (for cabinet base)
- Banking strip
- Common condiment type, telescoping plate rails (starting at 24" length).
- 10", 22", or 34" high back risers (no shelf)
- 22" single deck solid or flo-thru high shelf risers
- 34" double deck solid or flo-thru high shelf risers
- Dolly frames
- Flexible gas hose with quick disconnect & restraining device

**VULCAN**

a division of ITW Food Equipment Group LLC

P.O. Box 696 ■ Louisville, KY 40201 ■ Toll-free: 1-800-814-2028 ■ Local: 502-778-2791 ■ Quote &amp; Order Fax: 1-800-444-0602



**HEAVY DUTY GAS RANGE**  
**2 BURNERS / 18" T-STAT GRIDDLE**  
**36" WIDE GAS RANGE**

**INSTALLATION INSTRUCTIONS**

1. A properly sized gas pressure regulator suitable for battery or single unit application must be furnished and installed. Natural gas 6.0" W.C., propane gas 10.0" W.C.
2. An adequate ventilation system is required for commercial cooking equipment. Information may be obtained by writing to the National Fire Protection Association, 1 Batterymarch Park, Quincy, MA 02269, www.NFPA.org. When writing, refer to NFPA No. 96.
3. These units are manufactured for installation in accordance with ANSZ223.1A (latest edition), National Fuel Gas Code. Copies may be obtained from The American Gas Association, 400 N Capitol St. NW, Washington, DC 20001, www.AGA.org.

4. Clearances	Rear	Sides
Combustible	10"	10"
Non-combustible	0"	0"

5. For proper combustion, install equipment on adjustable legs or casters. On curb or platform, allow 3½" front overhang. Toe base with leveling bolts are required for curb installation. Specify when ordering.
6. Cannot be battered with GH series equipment.
7. This appliance is manufactured for commercial installation only and is not intended for home use.

**NOTE:** In line with its policy to continually improve its product, Vulcan reserves the right to change materials and specifications without notice.

**Specify type of gas when ordering.**  
**Specify altitude when above 2,000 feet.**

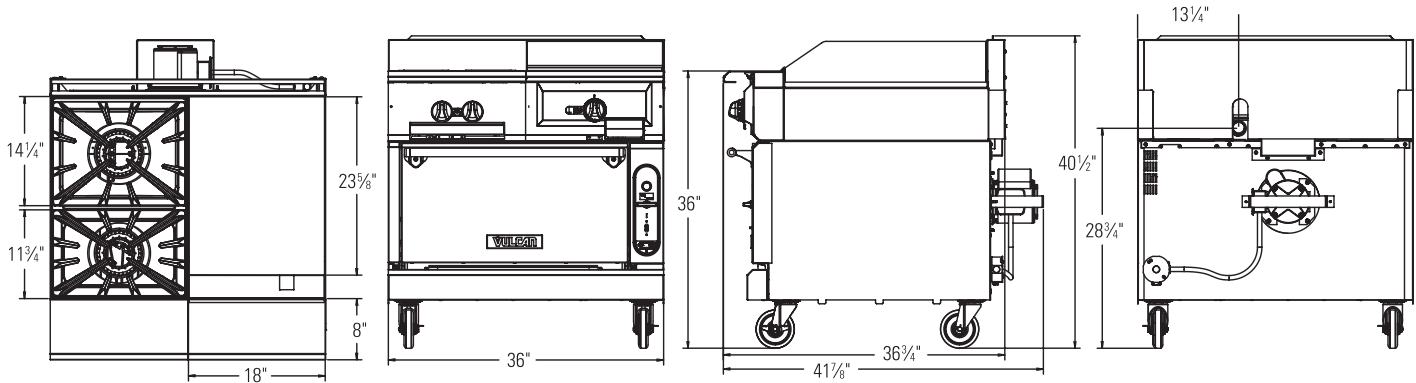

TOP CONFIGURATION	MODEL NUMBER	DESCRIPTION	TOTAL INPUT BTU / HR	SHIPPING WEIGHT LBS / KG
	<b>V2BG8T</b>	2-Burners / 18" T-Stat Griddle / Modular	96,000	332 / 151
	<b>V2BG8TB</b>	2-Burners / 18" T-Stat Griddle / Cabinet Base	96,000	432 / 196
	<b>V2BG8TS</b>	2-Burners / 18" T-Stat Griddle / Standard Oven Base	146,000	613 / 279
	<b>V2BG8TC</b>	2-Burners / 18" T-Stat Griddle / Convection Oven Base	128,000	691 / 314



a division of ITW Food Equipment Group LLC

P.O. Box 696 ■ Louisville, KY 40201 ■ Toll-free: 1-800-814-2028 ■ Local: 502-778-2791 ■ Quote & Order Fax: 1-800-444-0602

**NOTE:** In line with its policy to continually improve its products, Vulcan reserves the right to change materials and specifications without notice.