

STEAM**VULCAN****VG SERIES
MODULAR GAS TILTING BRAISING PAN**

Shown with enclosed faucet bracket



ANSI/NSF Standard #4

SPECIFICATIONS

Modular gas tilting braising pan, Vulcan-Hart Model No. (VG30) (VG40). 36"/46" wide open base. Stainless steel front, sides and 12" legs with adjustable flanged feet. Stainless steel back. Front hinged polished stainless steel pan body with coved interior corners and embossed gallon markings. Stainless steel cooking surface bonded to steel plate. Full width 4" return flange with formed pouring lip and removable strainer. Stainless steel spring assist cover with wrap around handle and condensate lip. Faucet mounting bracket (non-enclosed) field reversible "L" bracket either side. Drop away food pan receiving support mounts under pouring lip. Manually operated pan tilting mechanism with folding swing away handle. Pan can be fully tilted to empty completely with approximately 30 crank revolutions. One 30,000 BTU/hr. burner for each 12" pan width. Burners shut off when pan is tilted 5°. Electronic ignition system for automatic burner light. Solid state temperature controls. Water tight controls and enclosures. Requires a 120/60/1 electrical power supply, 3.0 amps total draw. 3/4" rear gas connection and gas pressure regulator.

Exterior dimensions: ___"w x 35 1/2"d x 40 1/2"h on 12" legs.

CSA design certified. Classified by U L to NSF Std. #4.

SPECIFY TYPE OF GAS WHEN ORDERING.

SPECIFY ALTITUDE WHEN ABOVE 2,000 FT.

- VG30** 36" wide open base.
- VG40** 46" wide open base.

STANDARD FEATURES

- Stainless steel front, sides and 12" legs with adjustable flanged feet.
- Stainless steel back.
- Front hinged polished stainless steel pan body with coved interior corners and embossed gallon markings. Stainless steel cooking surface bonded to steel plate. Full width 4" return flange with formed pouring lip and removable strainer.
- Stainless steel spring assist cover with wrap around handle and condensate lip.
- Stops in place for vented cooking.
- Faucet mounting bracket (non-enclosed) field reversible "L" bracket either side.
- Drop away food receiving pan support mounts under pouring lip.
- Manually operated pan tilting mechanism with folding swing away handle. Pan can be fully tilted to empty completely with approximately 30 crank revolutions.
- One 30,000 BTU/hr. burner for each 12" pan width. Burners shut off when pan is tilted 5°. Electronic ignition system for automatic burner lighting.
- Solid state temperature controls.
- Water tight controls and enclosures.
- Requires a 120/60/1 electrical power supply, 3.0 amps.
- 3/4" rear gas connection with gas pressure regulator.
- One year limited parts and labor warranty.

OPTIONS

- Motor driven pan lift.
- Two inch draw-off valve – left front straight with strainer. (BPDOV-1) Pan support will be removed on VG30.
- Two inch draw-off valve – left front 90° left with strainer. (BPDOV-2) Pan support will be removed on VG30.
- Two inch draw-off valve – left side 90° front with strainer. (BPDOV-3)
- Standard prison package includes:
 - Security screws and tackwelds.
 - Includes securing crank handle, pan strainer and non-door type panels.
 - Controls protected by lockable cover.
 - Perforated flue cover.
- Second year extended limited parts and labor warranty.

ACCESSORIES (Packaged & Sold Separately)

- Set of four casters, (four locking).
- Faucet bracket assembly (adds 3" to width).
- (12") (18") double jointed single pantry faucet.
- (12") (18") double jointed double pantry faucet.
- Double pantry washdown hose with 16" add-on faucet with backflow preventer.
- Double pantry washdown hose with backflow preventer.
- Double pantry pot filler and backflow preventer.
- Steaming pan insert rack to hold 12" x 20" pans. (Qty. ___)
- 12" x 20" x 4" stainless steel drain waste pan with clear plastic hose.
- Catch can with bail handle and drain hose for draw-off valve.
- Stainless steel perforated boiling basket (12" x 20" x 6" deep) with handles.

VULCAN

a division of ITW Food Equipment Group LLC

P.O. Box 696 ■ Louisville, KY 40201 ■ Toll-free: 1-800-814-2028 ■ Local: 502-778-2791 ■ Quote & Order Fax: 1-800-444-0602



VG SERIES MODULAR GAS TILTING BRAISING PAN

SERVICE CONNECTIONS:

GAS INPUT: 3/4" N.P.T., Nat. 6"-14" W.C., Propane, 11"-18" W.C. See capacity schedule.

ELECTRICAL CONNECTION: Control circuit 7/8" dia. 120 volt, 1 phase, 15 amps, power cord.

IMPORTANT:

1. A pressure regulator sized for this unit is included. Natural gas 7" W.C., propane gas 11" W.C. supply pressure.
2. Gas line connecting to appliance must be 3/4" or larger. If flexible connectors are used, the inside diameter must be at least the same as the 3/4" iron pipe.
3. An adequate ventilation system is required for commercial cooking equipment. Information may be obtained by writing to the National Fire Protection Association, Batterymarch Park, Quincy, MA 02289. When writing, refer to NFPA No. 96.

4. These units are manufactured for installation in accordance with ANSZ223.1A (Latest edition), National Fuel Gas Code. Copies may be obtained from the American Gas Association, 1515 Wilson Blvd., Arlington, VA 22209.

5. Clearances:	Combustible	Non-combustible
Rear	6	0
Sides	2	0

6. This appliance is manufactured for commercial installation only and is not intended for home use.

MODEL	COOKING SURFACE AREA	CAPACITY	4 OZ. PORTIONS
VG30	29" x 23"	30 gal./114 liters	960
VG40	39" x 23"	40 gal./152 liters	1280

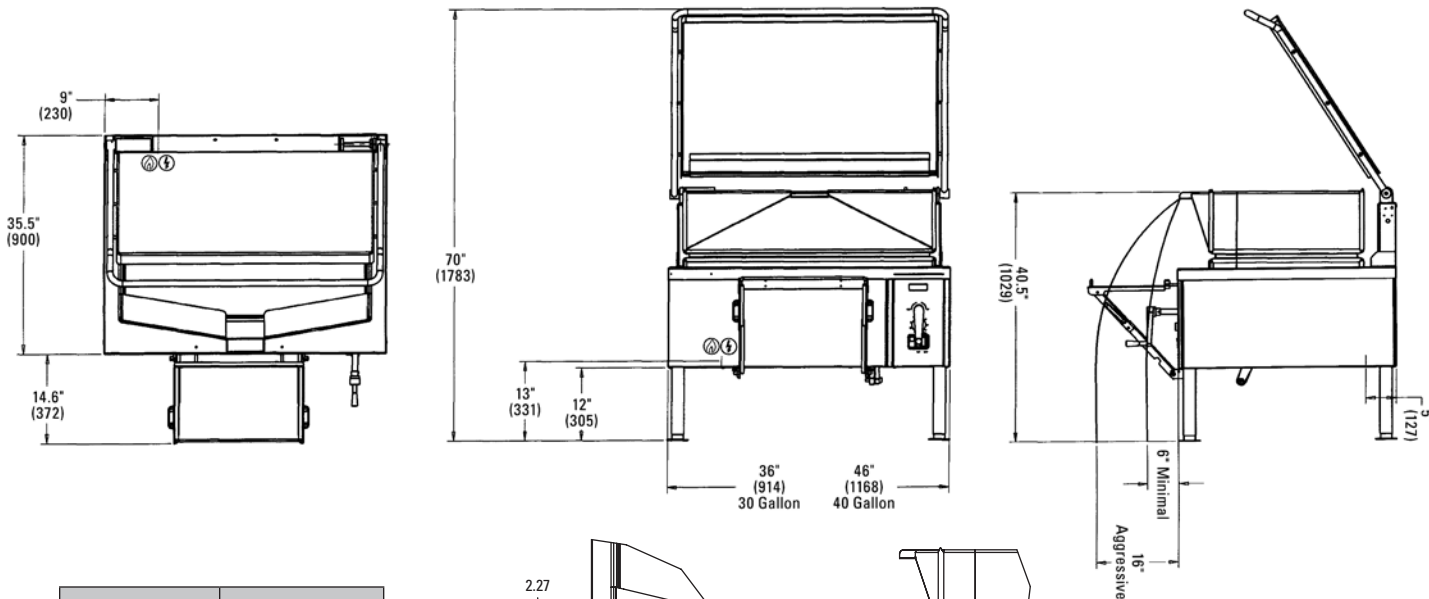

MODEL	BTU/HR. INPUT
VG30	90,000
VG40	120,000

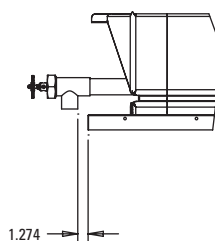
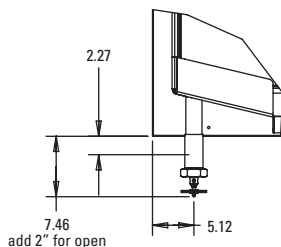

2" Draw-off valve – left front straight (BPDOV-1)

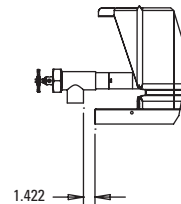
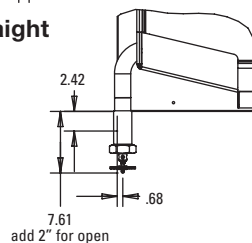
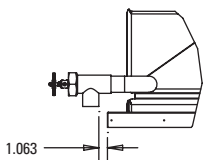
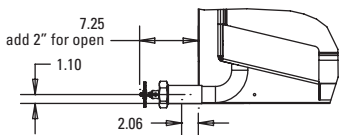

2" Draw-off valve – left front 90° left (BPDOV-2)

2" Draw-off valve – left side 90° front (BPDOV-3)



a division of ITW Food Equipment Group LLC

P.O. Box 696 ■ Louisville, KY 40201 ■ Toll-free: 1-800-814-2028 ■ Local: 502-778-2791 ■ Quote & Order Fax: 1-800-444-0602

NOTE: In line with its policy to continually improve its products, Vulcan reserves the right to change materials and specifications without notice.